

### Ultrafast Rectifier

#### Features

- Ultrafast Recovery Time
- Low Forward Voltage Drop
- Low Leakage Current
- 175°C Operating Junction Temperature

$$t_{rr} = 40\text{ns}$$

$$I_{F(AV)} = 30\text{Amp}$$

$$V_R = 300\text{V}$$

#### Description/ Applications

International Rectifier's 300V series are the state of the art Ultrafast recovery rectifiers designed with optimized performance of forward voltage drop and Ultrafast recovery time.

The planar structure and the platinum doped life time control guarantee the best overall performance, ruggedness and reliability characteristics.

These devices are intended for use in the output rectification stage of SMPS, UPS, DC-DC converters as well as freewheeling diodes in low voltage inverters and chopper motor drives.

Their extremely optimized stored charge and low recovery current minimize the switching losses and reduce over dissipation in the switching element and snubbers.

#### Absolute Maximum Ratings

Parameters		Max	Units
$V_{RRM}$	Repetitive Peak Reverse Voltage	300	V
$I_{F(AV)}$	Average Rectified Forward Current	15	A
	@ $T_C = 142^\circ\text{C}$	Total Device	
$I_{FSM}$	Non Repetitive Peak Surge Current	140	
	@ $T_J = 25^\circ\text{C}$	Per Leg	
$T_J, T_{STG}$	Operating Junction and Storage Temperatures	- 65 to 175	$^\circ\text{C}$

#### Case Styles

30CPH03



TO247

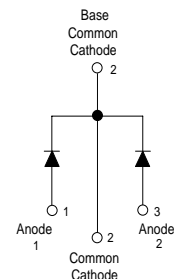

**Electrical Characteristics @  $T_J = 25^\circ\text{C}$  (unless otherwise specified)**

Parameters	Min	Typ	Max	Units	Test Conditions
$V_{BR}, V_f$ Breakdown Voltage, Blocking Voltage	300	-	-	V	$I_R = 100\mu\text{A}$
$V_F$ Forward Voltage	-	1.05	1.25	V	$I_F = 15\text{A}, T_J = 25^\circ\text{C}$
	-	0.85	1.00	V	$I_F = 15\text{A}, T_J = 125^\circ\text{C}$
$I_R$ Reverse Leakage Current	-	0.05	40	$\mu\text{A}$	$V_R = V_R$ Rated
	-	12	400	$\mu\text{A}$	$T_J = 125^\circ\text{C}, V_R = V_R$ Rated
$C_T$ Junction Capacitance	-	45	-	pF	$V_R = 300\text{V}$
$L_S$ Series Inductance	-	8	-	nH	Measured lead to lead 5mm from package body

**Dynamic Recovery Characteristics @  $T_J = 25^\circ\text{C}$  (unless otherwise specified)**

Parameters	Min	Typ	Max	Units	Test Conditions
$t_{rr}$ Reverse Recovery Time	-	-	40	ns	$I_F = 1.0\text{A}, di_F/dt = 50\text{A}/\mu\text{s}, V_R = 30\text{V}$
	-	32	-		$T_J = 25^\circ\text{C}$
	-	45	-		$T_J = 125^\circ\text{C}$
$I_{RRM}$ Peak Recovery Current	-	2.4	-	A	$T_J = 25^\circ\text{C}$
	-	6.1	-		$T_J = 125^\circ\text{C}$
$Q_{rr}$ Reverse Recovery Charge	-	38	-	nC	$T_J = 25^\circ\text{C}$
	-	137	-		$T_J = 125^\circ\text{C}$

$I_F = 15\text{A}$   
 $di_F/dt = -200\text{A}/\mu\text{s}$   
 $V_R = 200\text{V}$

**Thermal - Mechanical Characteristics**

Parameters	Min	Typ	Max	Units
$T_J$ Max. Junction Temperature Range	- 65	-	175	$^\circ\text{C}$
$T_{Stg}$ Max. Storage Temperature Range	- 65	-	175	
$R_{thJC}$ Thermal Resistance, Junction to Case		0.9	2.0	$^\circ\text{C}/\text{W}$
$R_{thJA}^*$ Thermal Resistance, Junction to Ambient		-	40	
$R_{thCS}'$ Thermal Resistance, Case to Heatsink		0.4	-	
$Wt$ Weight	-	6.0	-	g
	-	0.21	-	(oz)
Mounting Torque	6.0	-	12	Kg-cm
	5.0	-	10	lbf.in

- \* Typical Socket Mount
- ' Mounting Surface, Flat, Smooth and Greased

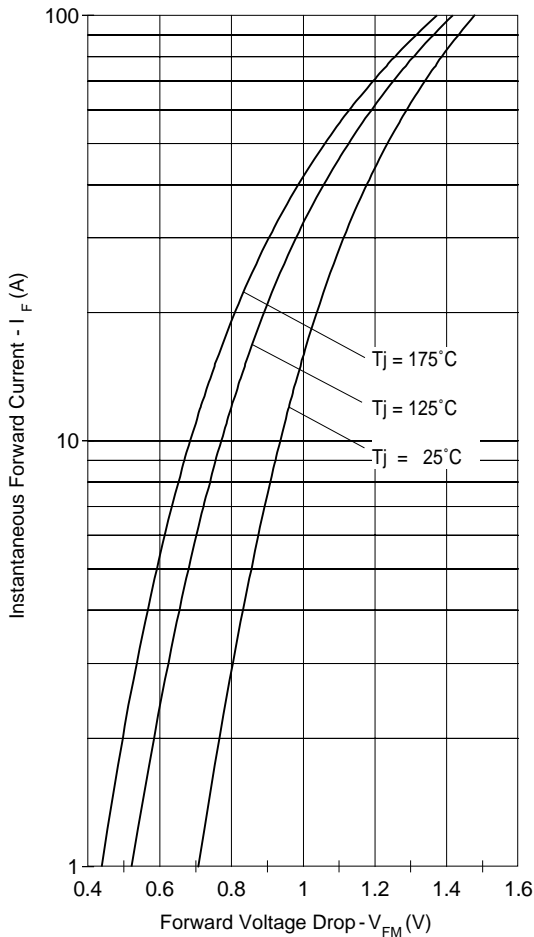

**Fig. 1 - Typical Forward Voltage Drop Characteristics**

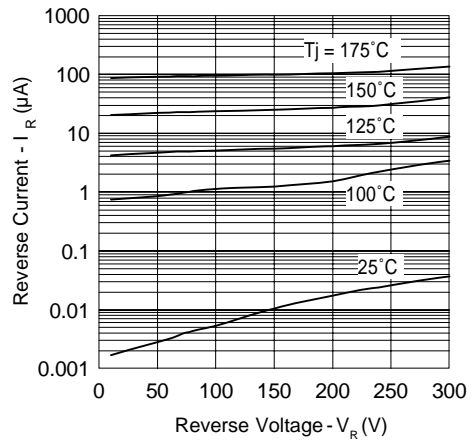

**Fig. 2 - Typical Values Of Reverse Current Vs. Reverse Voltage**

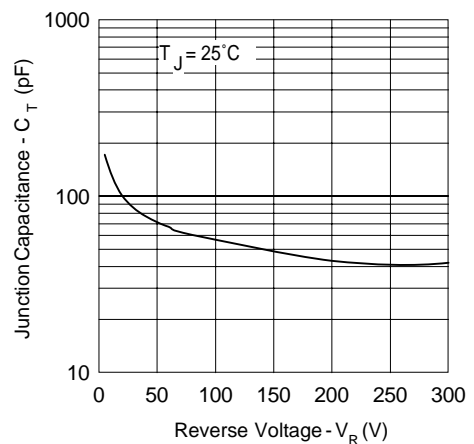

**Fig. 3 - Typical Junction Capacitance Vs. Reverse Voltage**

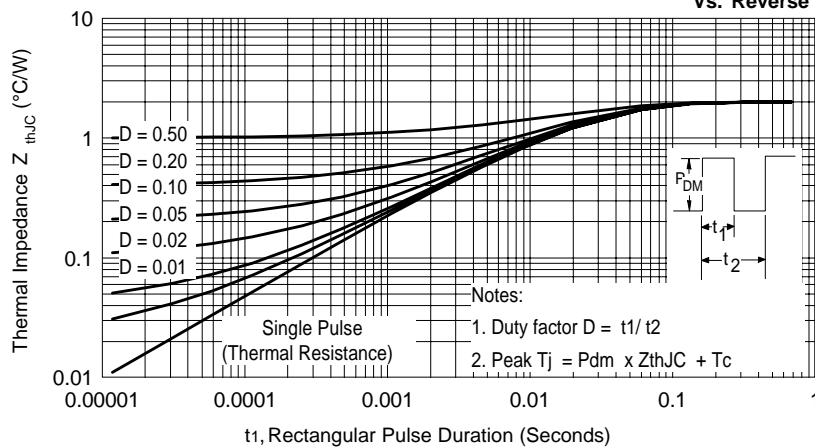

**Fig. 4 - Max. Thermal Impedance  $Z_{thJC}$  Characteristics**

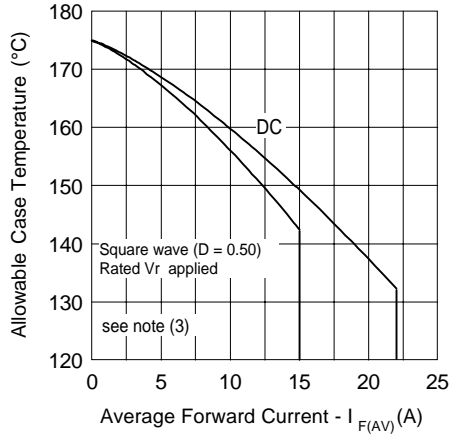

Fig. 5 - Max. Allowable Case Temperature Vs. Average Forward Current

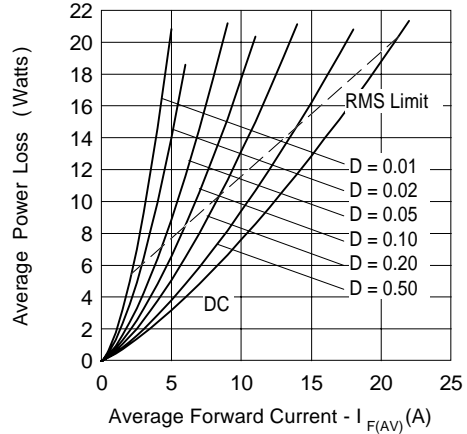

Fig. 6 - Forward Power Loss Characteristics

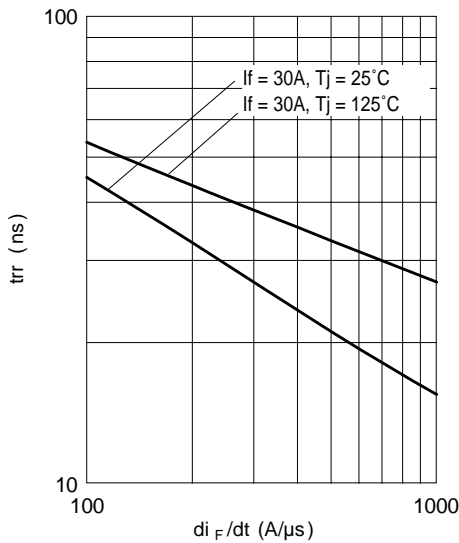

Fig. 7 - Typical Reverse Recovery vs.  $di_F/dt$

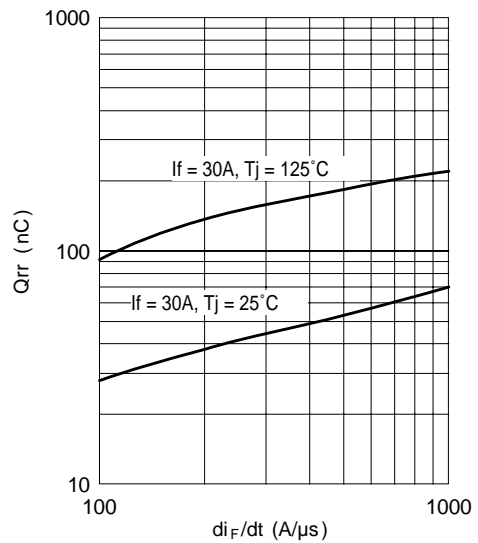
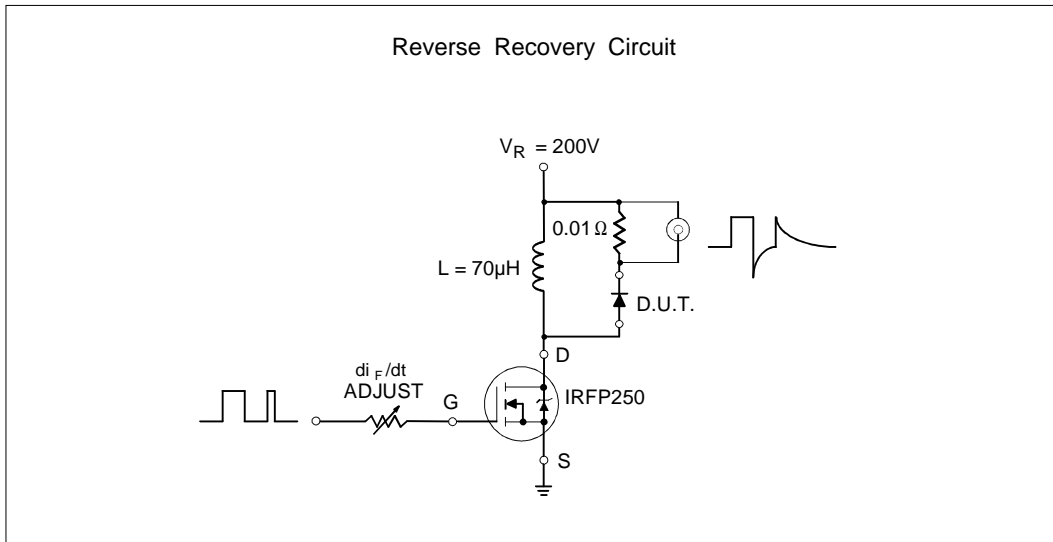
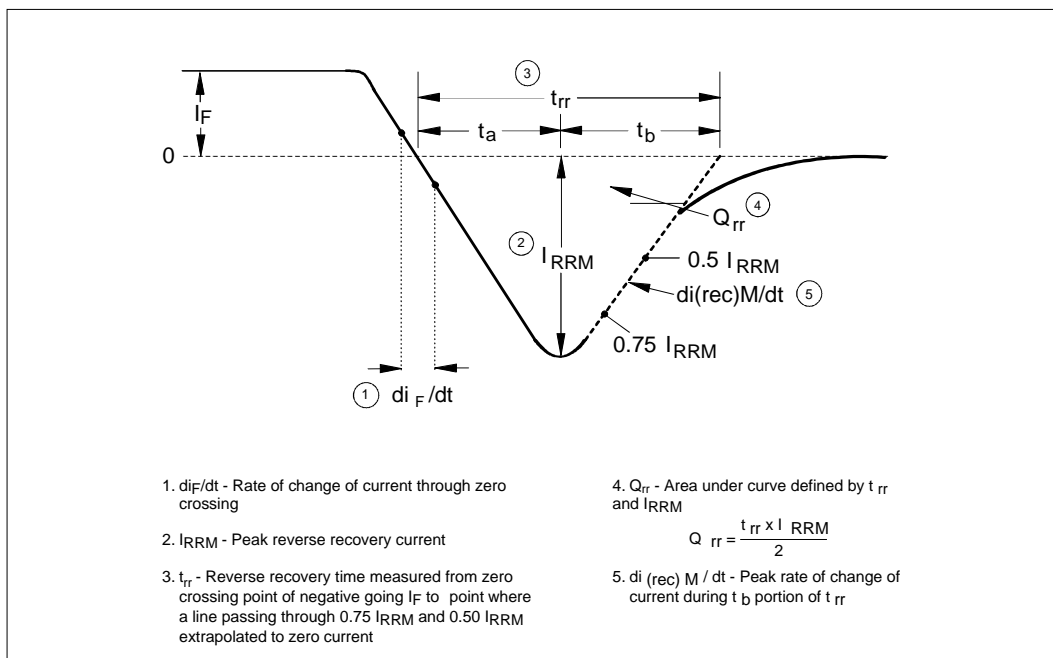

Fig. 8 - Typical Stored Charge vs.  $di_F/dt$

(3) Formula used:  $T_C = T_J - (Pd + Pd_{REV}) \times R_{thJC}$ ;  
 $Pd = \text{Forward Power Loss} = I_{F(AV)} \times V_{FM} @ (I_{F(AV)}/D)$  (see Fig. 6);  
 $Pd_{REV} = \text{Inverse Power Loss} = V_{R1} \times I_R (1-D); I_R @ V_{R1} = \text{rated } V_R$

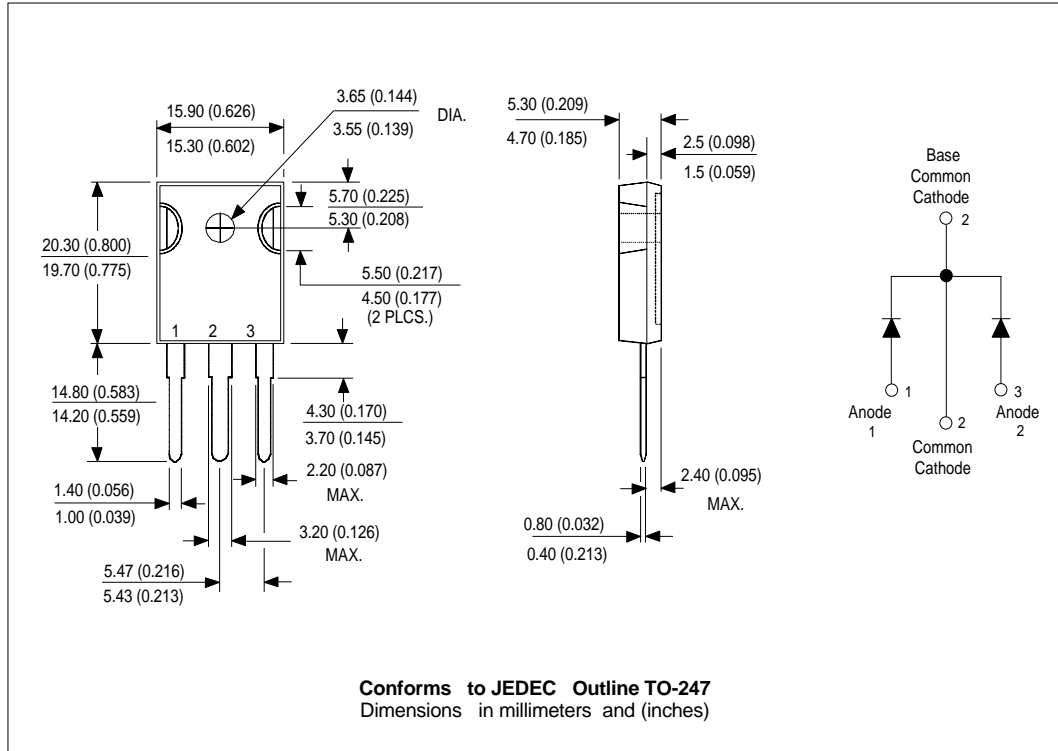

**Fig. 9 - Reverse Recovery Parameter Test Circuit**

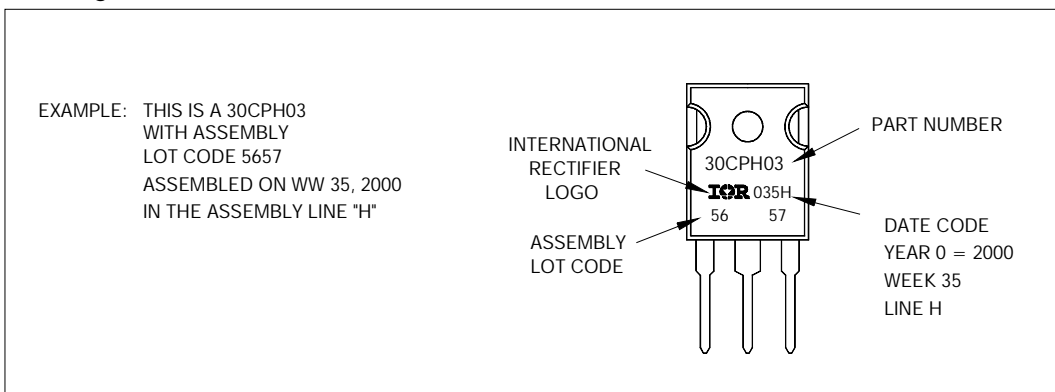

**Fig. 10 - Reverse Recovery Waveform and Definitions**

Outline Table



Marking Information



Data and specifications subject to change without notice.  
This product has been designed and qualified for Industrial Level.  
Qualification Standards can be found on IR's Web site.

International  
**IOR** Rectifier

**IR WORLD HEADQUARTERS:** 233 Kansas St., El Segundo, California 90245, USA Tel: (310) 252-7105  
TAC Fax: (310) 252-7309  
Visit us at [www.irf.com](http://www.irf.com) for sales contact information. 04/03